

KD 724

Hochdruck Dreiplunger-Pumpe

P max. 170 kW

Die robuste Verdrängerpumpe KD724 ist in unterschiedlichen Antriebs- und Flüssigkeitsteil-Varianten erhältlich.

Haupt-Einsatzgebiete sind in Industrie und Dienstleistung.

Als Prozesspumpe wird die KD724 mit individuell angepasstem Flüssigkeitsteil zum Fördern von dünnflüssigen, pastösen, aggressiven, neutralen, abrasiven, sehr heißen oder toxischen Medien eingesetzt.

Die ausgereifte Pumpenkonstruktion führt zu geringem Energieverbrauch durch hohe mechanische Wirkungsgrade bei verschleißarmem Betrieb.

High pressure triplex plunger pump

P max. 170 kW

The sturdy reciprocating pump type KD724 is available in various drive and liquid end configurations.



Main applications are in industry and service sector.

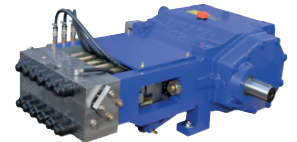

Process pump KD724 with customized liquid end is used for handling thin liquids to pasty substances with aggressive, neutral, abrasive, hot or toxic properties.

Minimum energy consumption and low-wear operation due to high mechanical efficiency, based on a sophisticated pump conception.

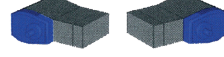

Flüssigkeitsteile Liquid ends
Version A1 Gussausführung mit Einzelstopfbuchsen. Casting design with single stuffing boxes. 
Version A2, B, C, D, E Edelstahl Ausführung mit Einzelstopfbuchsen. Stainless steel with single stuffing boxes. 
Klarwasserausführung. Clear water model.
Heisswasserausführung. Hot water model.
Ventilanhebung zur Entwässerung. Valve-lift for drainage.
Saugventilauflösung zur verschleißfreien Last-, Leerlaufumschaltung optional. Optional suction valve release for wear free load, unload change over.

Antrieb Drive
KD 724 Ohne integriertes Getriebe. Without integral gear. 
KD 724 G Mit integriertem Getriebe. With integral gear. 
Triebwerk Power ends
Druckschmierung intern obligatorisch, extern optional Standard pressure lubrication internal or external optional.
Triebwerkskühler entsprechend Einsatzbedingungen. Power end cooler subject to field of application.

Bauweise Design
Links- oder Rechtsausführung. Left or right hand drive. 
Liegende oder stehende Ausführung. In horizontal or vertical design. 

Technische Daten

Technical Data

Getriebeübersetzung Gear ratio				Antriebsdrehzahl Drive speed min ⁻¹																					
i = 4,20				210	420	630	840	1050	1260	1470	1680	1785	1890	1932	1974	2016	2058	2100	2142	2184	2226	2268	2310	2352	2394
i = 3,73				186	373	559	745	932	1118	1305	1491	1584	1677	1715	1752	1789	1826	1864	1901	1938	1975	2013	2050	2087	2125
i = 3,16				158	316	474	632	790	948	1106	1264	1343	1422	1454	1485	1517	1548	1580	1612	1643	1675	1706	1738	1770	1801
i = 2,68				134	268	402	536	670	804	938	1071	1138	1205	1232	1259	1286	1313	1339	1366	1393	1420	1446	1473	1500	1527
Pumpendrehzahl Pump speed		min ⁻¹		50	100	150	200	250	300	350	400	425	450	460	470	480	490	500	510	520	530	540	550	560	570
Druck Pressure bar	Plunger Plunger Ø mm			Förderstrom Capacity												I/min (±2%)									
				Antriebsleistung Power required												kW (+3%)									
A1	170	70	I/min	48	96	144	192	240	288	336	384	408	433	442	452	461	471	481	490	500	509	519	529	538	548
			kW	15,5	30	45	60	75	89	104	119	127	134	137	140	143	146	149	152	155	158	161	164	167	170
	200	65	I/min	41	82	124	165	206	247	288	330	350	371	379	387	396	404	412	420	429	437	445	453	462	470
			kW	15,5	30	45	60	75	90	105	120	128	135	138	141	144	147	150	153	156	159	162	165	168	171
230	60	I/min	35	70	104	139	174	209	244	278	296	313	320	327	334	341	348	355	362	369	376	383	390	397	
		kW	14,5	29	44	58	73	88	102	117	124	131	134	137	140	143	146	149	152	155	158	161	163	166	
275	55	I/min	29	58	87	116	145	174	202	231	246	260	266	272	278	283	289	295	301	307	312	318	324	330	
		kW	14,5	29	43	58	72	87	101	116	123	130	133	136	139	142	145	148	151	154	156	159	162	165	
A2	130	80	I/min	61	123	184	246	307	369	430	491	522	553	565	577	590	600	615	625	640	650	665	675	690	700
			kW	14,5	29	44	58	73	88	102	117	124	131	134	137	140	143	146	149	152	155	158	161	163	166
	150	75	I/min	54	108	162	216	270	324	378	432	459	486	497	507	518	529	540	551	561	572	583	594	605	615
			kW	15,5	30	44	59	74	89	104	118	126	133	136	139	142	145	148	151	154	157	160	163	166	169
	170	70	I/min	48	96	144	192	240	288	336	384	408	433	442	452	461	471	481	490	500	509	519	529	538	548
			kW	15,5	30	45	60	75	89	104	119	127	134	137	140	143	146	149	152	155	158	161	164	167	170
	200	65	I/min	41	82	124	165	206	247	288	330	350	371	379	387	396	404	412	420	429	437	445	453	462	470
			kW	15,5	30	45	60	75	90	105	120	128	135	138	141	144	147	150	153	156	159	162	165	168	171
230	60	I/min	35	70	104	139	174	209	244	278	296	313	320	327	334	341	348	355	362	369	376	383	390	397	
		kW	14,5	29	44	58	73	88	102	117	124	131	134	137	140	143	146	149	152	155	158	161	163	166	
275	55	I/min	29	58	87	116	145	174	202	231	246	260	266	272	278	283	289	295	301	307	312	318	324	330	
		kW	14,5	29	43	58	72	87	101	116	123	130	133	136	139	142	145	148	151	154	156	159	162	165	
B	410	45	I/min	19,5	39	58	78	97	117	136	156	166	175	179	183	187	191	195							
			kW	14,5	29	43	58	72	87	101	116	123	130	133	136	139	142	145							
	520	40	I/min	15,5	30	46	61	76	91	106	122	129	137	140	143	146	149	152	155	158	161	164	167	170	173
			kW	14,5	29	43	57	71	86	100	114	121	129	131	134	137	140	143	146	149	151	154	157	160	163
	675	35	I/min	11,5	23	34	45	57	68	80	91	97	102	105	107	109	111	114	116	118	120	123	125	127	130
			kW	14,5	28	41	55	69	83	97	111	118	124	127	130	133	135	138	141	144	147	149	152	155	158
800	32	I/min	9,5	19	28	37	46	56	65	74	79	84	86	87	89	91	93	95	97	99	100	102	104	106	
		kW	13,5	27	40	53	67	80	94	107	114	120	123	126	128	131	134	136	139	142	144	147	150	152	
C	800	32	I/min	7,5	15	22	29	36	43	50	57	61	64	66	67	69	70	72	73	74	76	77	79	80	82
			kW	13,5	27	40	54	67	80	94	107	114	121	123	126	129	131	134	137	139	142	145	147	150	153
	1050	28	I/min	5,5	11	17	22	28	34	39	45	48	50	52	53	54	55	56	57	58	59	60	62	63	64
			kW	12,5	24	36	48	60	72	84	96	102	108	110	112	115	117	120	122	124	127	129	131	134	136
D	1600	22	I/min	4,4	9	14	18	22	27	31	35	38	40	41	42	43	44	45	46	47	48	49	50	51	
			kW	12,5	25	37	50	62	75	87	100	106	112	115	117	120	122	125	127	130	132	135	137	140	142
	2000	20	I/min	3,5	7	11	14	17,5	21	24	28	30	31	32	33	34	34	35	36	36	37	38	38	39	40
			kW	12,5	24	36	49	61	73	85	97	103	109	112	114	117	119	122	124	127	129	131	134	136	139
2500	18	I/min	2,9	6	9	12	14,5	18	20	23	25	26	27	27	28										
		kW	12,5	25	37	50	62	75	87	100	106	112	115	117	120										
2800	17	I/min	2,5	5	8	10	12,5	15	18	20	21	23													
		kW	12,5	24	36	48	60	72	83	95	101	107													
E	3000	17	I/min	2,5	5	8	10	12,5	15	17	20	21													
			kW	12,5	25	38	50	63	75	88	100	105													

1 bar = 14,5038 psi; 1 l/min = 0,26417 USGPM = 0,22 IPGPM; 1 kW = 1,3410 HP; 1 mm = 0,03937 inch

Weitere technische Spezifikationen siehe Seite 4.

See page 4 for further technical specification.

Abmessungen

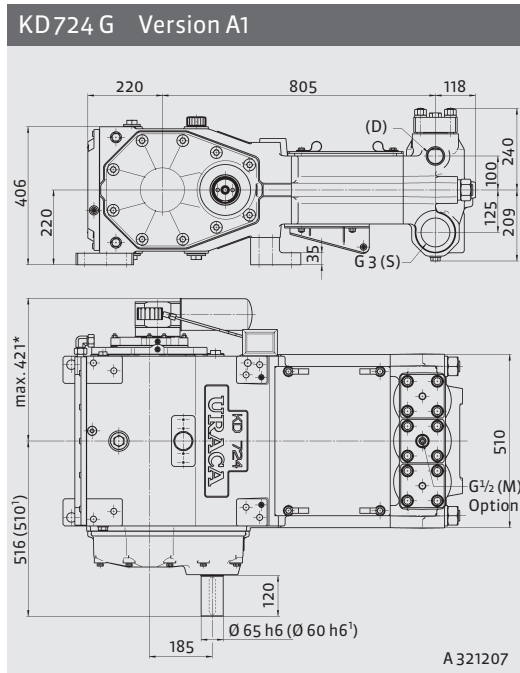

Dimensions

- * Maß abhängig von der Schmierölversorgung
- ¹ Maß gültig für Getriebeübersetzung i=4,2
- D Druckanschluss
- S Sauganschluss
- M Manometeranschluss

- * Dimensions depending on lubrication supply
- ¹ Dimensions are valid for gear ratio i=4.2
- D Pressure connection
- S Suction connection
- M Pressure gauge connection

KD724 G stehend / vertical

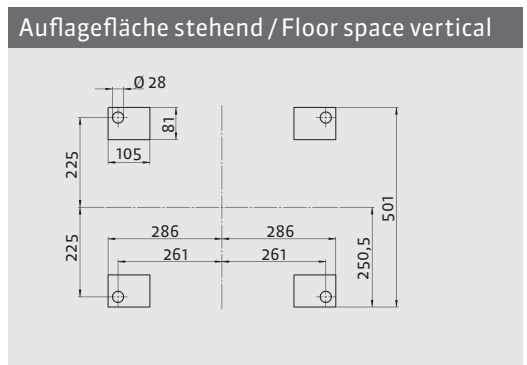
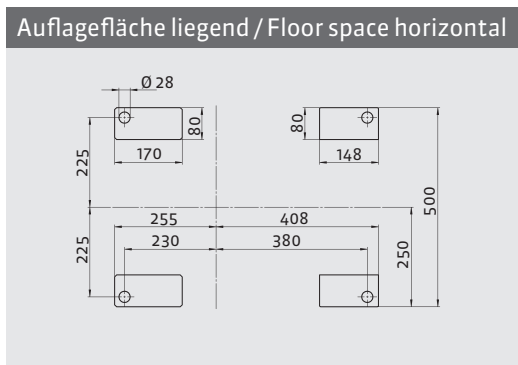
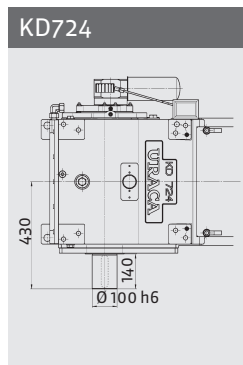
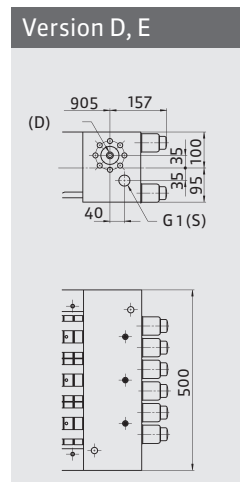
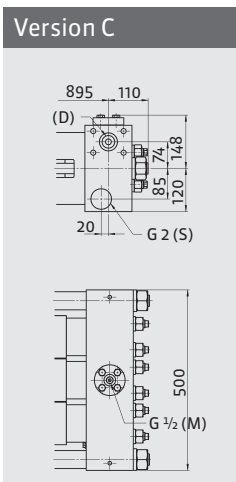
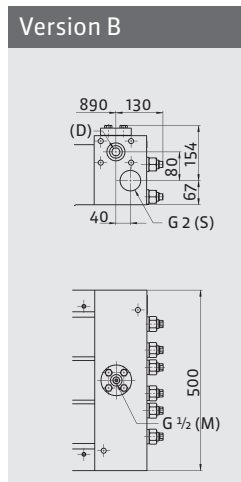
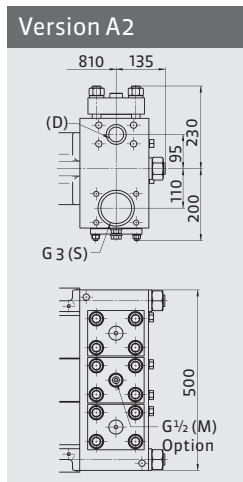
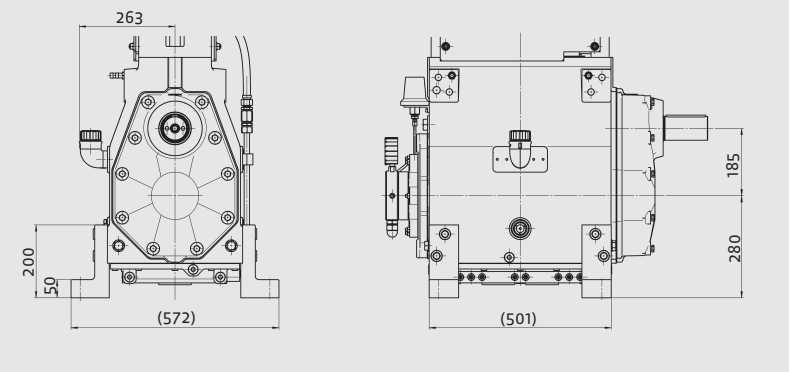

Gewichte

Ausführung Design	Gewicht (kg) Weight (kg)	Gewicht (lbs) Weight (lbs)
KD724G Version A1	670	1477
KD724G Version A2	765	1687
KD724G Version B	700	1543
KD724G Version C	720	1587
KD724G Version D	725	1598
KD724G Version E	725	1598

Gewichtsangaben ohne Öl, Abweichungen bedingt durch verschiedene Optionen möglich.

Technische Spezifikationen

Hub = 85 mm

Zulässige radiale Antriebswellenbelastung auf Anfrage.

Kurbelwellenüberlastsicherung optional.

Drehrichtung wählbar.

Die angegebenen Förderströme und Antriebsleistungen gelten für Wasser, volumetrische und mechanische Wirkungsgrade sind dabei berücksichtigt.

Ausführung des Flüssigkeitsteils abhängig von Fördermedium und Einsatzbedingungen.

Andere Betriebsdaten und detaillierte Abmessungen auf Anfrage.

Konstruktionsbedingt sind Drehzahleinschränkungen bei verschiedenen Druckstufen notwendig.

Erforderliche Zulaufdrücke sind abhängig von Einsatzbedingungen und Pumpenausführung.

Saug- und Druckanschlüsse beidseitig rechts und links möglich.

Antriebslage wahlweise rechts oder links möglich.

Konstruktionsänderungen vorbehalten. Maße, Gewichte, Abbildungen und Daten unverbindlich. Fördermengenangaben basieren auf Standard Ventil Konfiguration.

Weights

Weight without oil, differences are subject to different options.

Technical Specification

Stroke = 85 mm

Admissible radial load of drive shaft upon request.

Optional crankshaft overload protection.

Direction of rotation selectable.

Capacity and recommended motor ratings as mentioned apply to water, the average volumetric and mechanical efficiency are taken into consideration.

Liquid end design depends on liquid handled and operation conditions.

Other operating data and detailed dimensions are available on request.

Speed limitation at different pressure stages is due to design.

The required suction pressure depends on application and pump design.

Suction and discharge connections are available on both sides, right and left.

Drive position can be selected on the right or left side.

Design may be subject to modification. Dimensions, weights, illustrations and technical data are without engagement. Flowrates based on standard valve configuration.